

# NEOMITIS

## INSTALLATION

# INSTRUCTIONS

RTE7D  
RTE7BD

## WIRED DIGITAL 7 DAY PROGRAMMABLE ROOM THERMOSTAT

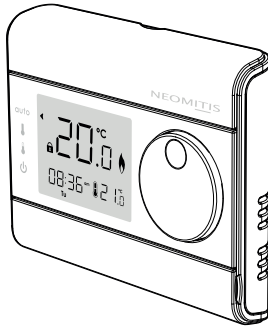

### TABLE OF CONTENTS

Pack contains.....	1
Installation .....	1
Installing batteries.....	1
Mounting of wall mounting plate.....	1
Wiring.....	1
Mounting of the Thermostat .....	2
Installer settings .....	2
Advanced installer setting.....	2
Troubleshooting .....	4
Technical specifications .....	4

### PACK CONTAINS

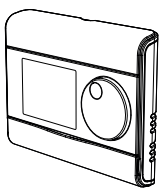

x1  
Thermostat

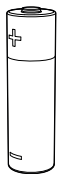

x2  
AA Batteries (LR6)



x2  
Screw Anchor

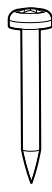

x2  
Screws

### INSTALLATION

#### Recommended locations for your thermostat.

To ensure that your thermostat provides accurate readings and controls effectively, it must be installed approximately 1.5 m above floor level on an inside wall, away from direct sunshine and any other sources of heat or cold such as radiators, cold draughts, etc.

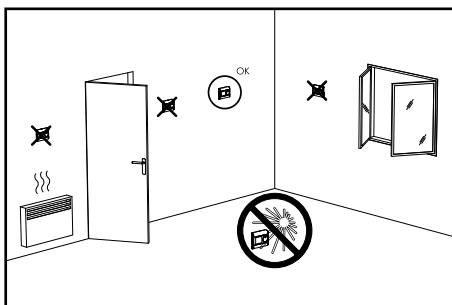

**Important:** The thermostat measures the temperature of the place where it is installed. It does not take into account the temperature differences that may exist between different locations in the house if the temperature is not uniform.

### INSTALLING BATTERIES

1- Remove the batteries cover which is placed on the front of thermostat.

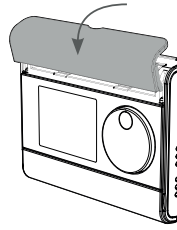

2- Insert the 2 batteries AA supplied. Note the correct polarity according to the engraving on the thermostat when inserting the batteries.

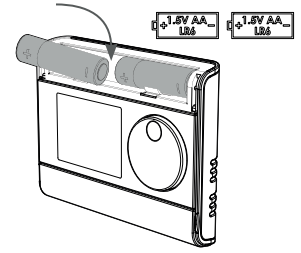

3- Replace the batteries cover.

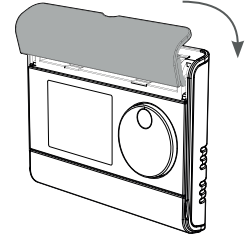

### MOUNTING OF WALL MOUNTING PLATE

The digital room thermostat is fixed on the wall with the wall plate which is supplied with the product.

1- Unscrew the 2 screws under the thermostat.

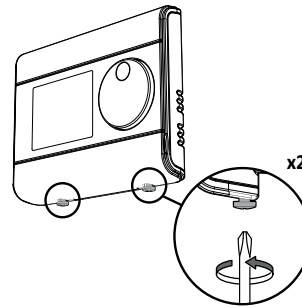

2- Remove the wall plate from the thermostat.



3- Secure the wall plate with the two screws provided using the horizontal and vertical holes.

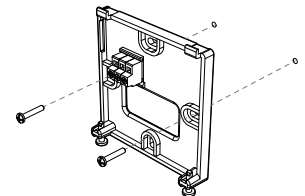

### WIRING



All electrical installation work should be carried out by a suitably qualified Electrician or other competent person. If you are not sure how to install this thermostat consult either with a qualified electrician or heating Engineer. Do not remove or refit the appliance onto the backplate without the mains supply to the system being isolated.

All wiring must be in accordance with IEE regulations. This product is for fixed wiring only.

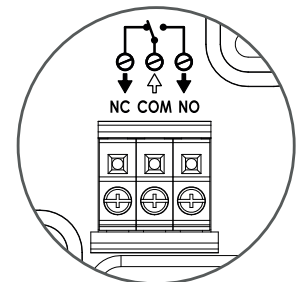
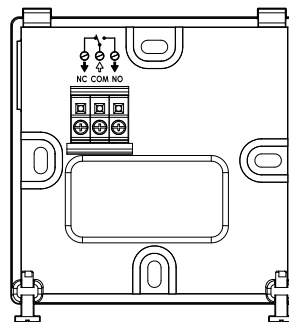

COM = Live  
NC = Normally closed switch out (Satisfied)  
NO = Normally open switch out (call for Heat)

## MOUNTING OF THE THERMOSTAT

1- Replace the thermostat on the wall mounting plate.

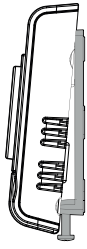

2- Secure the thermostat by screwing the both locking screws under the thermostat.

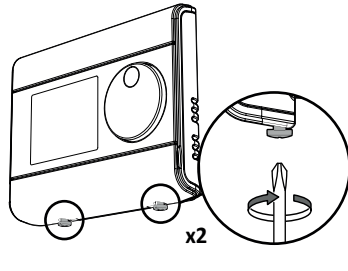

## PLEASE READ BEFORE PROGRAMMING THE THERMOSTAT

### OPTIMISATION EXPLAINED

#### WHAT IS OPTIMISATION – OPTIMUM START?

Historically, most UK heating systems waste vast amounts of energy by firing unnecessarily early for most of the year. Homeowners tend to set their boiler on times based on when they wake up by guessing what time they feel that their boiler should fire in order to reach the requested target temperature; for example turning the boiler on at 6am in order to have a warm room/ home by their wake up time at 7am.

**Dual function optimisation , priority to comfort or energy savings, the choice is yours:** Depending on various parameters: room inertia, ambient temperature, desired temperature, the thermostat calculates and optimizes the programming for each heating period whether set to Comfort or Savings (Eco):

#### In OPTI COMFORT mode, priority to comfort

In OPTI COMFORT mode, the thermostat's inbuilt algorithm optimises in order to guarantee maximum comfort during the COMFORT programme.

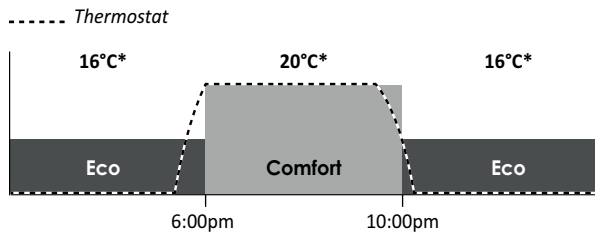

\*Default temperature setting

The processor within the thermostat starts the boiler operation at the optimum time to achieve the setpoint temperature at the start of the occupancy period.

In this mode, the priority is given to anticipating and maintaining the comfort temperature during periods of occupancy.

#### In OPTI ECO mode, priority to energy savings

In OPTI ECO mode, the thermostat's inbuilt algorithm optimises in order to guarantee maximum energy savings throughout the ECO programme.

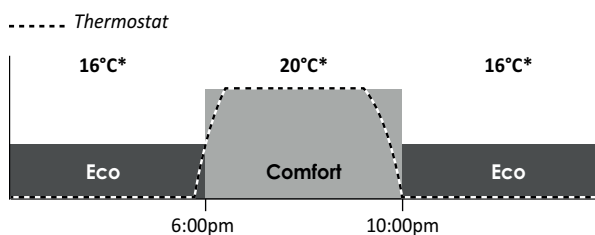

\*Default temperature setting

In this mode, a slight drop in the temperature level at the beginning and end of the comfort period is allowed to maximize energy savings.

## PLEASE READ BEFORE PROGRAMMING THE THERMOSTAT

Instead of using a fixed start time, Optimum Start calculates how long the house will take to warm up depending on the temperature of the home, then fires the boiler automatically at the most efficient moment in order to reach your target temperature by your programmed time.

### HOW DOES OPTIMUM START WORK?

Optimum Start works on a daily basis. You set the time that you want to be warm and Optimum Start will do the rest; for example - **if you wake up at 7:30AM, then set your thermostat's start time for 7:30AM.** Optimum Start ensures that you are warm when you want to be (and not before), reducing wasted energy and saving money (up to 10% of energy costs).

To change the optimisation type, refer to the installation instructions/ advanced installer settings.

## INSTALLER SETTINGS

### ADVANCED INSTALLER SETTING

#### Access

Move the mode slider to position.

Select the Programming slider position and press **Enter** for **5 seconds** to go into the dedicated installer setting.

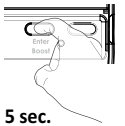

5 sec.

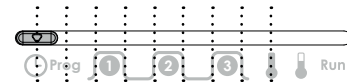

Slider position	Installer mode access
1	Set 12 or 24 hours clock
2	Enable/disable automatic summer/winter change
3	Set °C/°F temperature unit
4	Set calibration of the temperature displayed
5	Program lock
6	Select the type of control: 2 points or TPI
9	Optimisation choice

#### Set 12/24 hours clock



The pre-set value is 12 hours clock.

1- Rotate the dial to change to "24 hr".



2- Then save by pressing **Enter** or move the Programming slider.

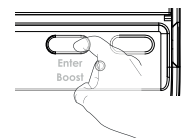

#### Enable/disable automatic summer/winter change over



The summer/winter change will be performed automatically by the room thermostat.

- 1- Press and hold **Enter** for 5 seconds to access the setting mode.

ON appears on the display.

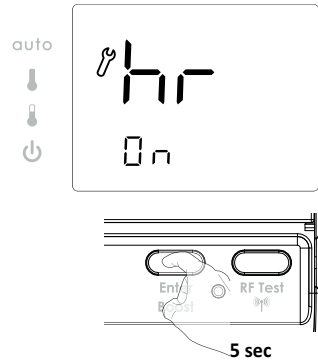

- 2- Rotate dial to the left to select "Off", to the right to select "On".

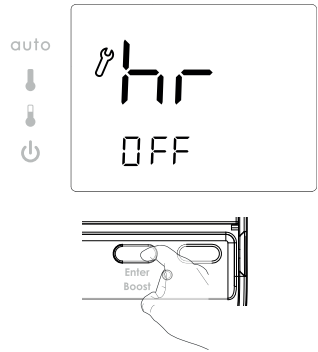

- 3- Then save by pressing **Enter** move the Programming mode.

### • Set °C/°F temperature

The pre-set temperature is Celsius (°C).

- 1- Rotate the dial to change to degree Fahrenheit.

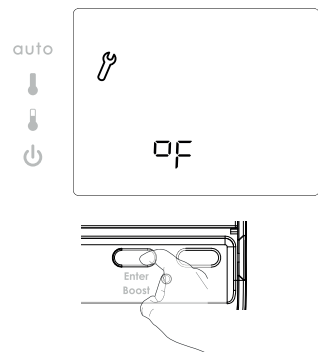

- 2- Then save by pressing **Enter** or move the Programming slider.

### • Set calibration

**Important: This operation is reserved for professional installers only; any wrong changes would result in control anomalies.**

Change should only be made if the temperature measured (measured by a reliable thermometer) is different by at least 1°C compared to the setpoint temperature of the room thermostat.

The calibration adjusts the temperature measured by the ambient temperature sensor to compensate for a deviation from +3°C to -3°C in increments of 0.5°C.

**IMPORTANT: Before carrying out the calibration it is recommended to wait for 4h after a setpoint temperature modification to insure that the ambient temperature is stabilized.**

The pre-set calibration value is 0.

- 1- Rotate the dial to adjust the calibration to the desired value.

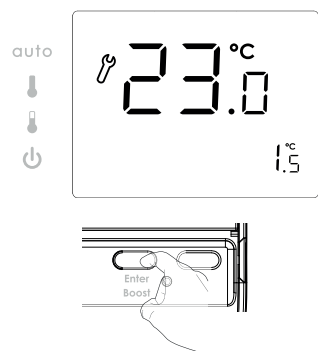

- 2- Then save by pressing **Enter** or move the Programming slider.

### • Program lock

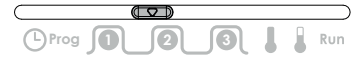

The product is unlocked by default, OFF is displayed.

When program lock function is turned on then following functions will be disabled:

- Regardless of physical location, Program Slider will always remain as per RUN mode (except to access Installer settings).
- In Mode Slider AUTO position: Manual override will not work.
- In Comfort Slider position: mode will remain as per AUTO mode.
- BOOST function is disabled.

- 1- Rotate the dial to ON and locked.



- 2- Then save by pressing **Enter** or move the Programming slider.

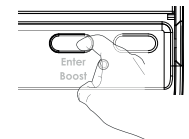

### • Select 2 points/TPI

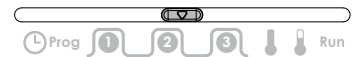

**2 points** = ON/OFF regulation.

**TPI** = Proportional control algorithm.

The pre-set control algorithm is TPI.

- 1- Rotate the dial to change to 2 points control algorithm.



- 2- Then save by pressing **Enter** or move the Programming slider.

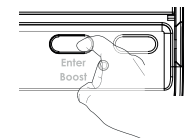

**Note regarding the Advanced installer settings:** If MODE slider is moved or no press/rotation for 15 seconds, it will discard changes and exit installer mode.

### • Optimisation feature



#### - Overview

**Dual function optimisation , priority to comfort or energy savings, the choice is yours:** Depending on various parameters: room inertia, ambient temperature, desired temperature, the thermostat calculates and optimizes the programming for each heating period whether set to Comfort or Savings (Eco):

- **In OPTI ECO mode**, the thermostat's inbuilt algorithm optimises in order to guarantee maximum energy savings throughout the ECO programme.

In this mode, a slight drop in the temperature level at the beginning and end of the ECO period is allowed to maximize energy savings. The processor within the thermostat stops the boiler operation at the optimum time to slightly reduce the setpoint temperature before the end of the occupancy period.

In this mode, a slight drop in the temperature level at the beginning and end of the comfort period is allowed to maximize energy savings.

- **In OPTI COMFORT mode**, the thermostat's inbuilt algorithm optimises in order to guarantee maximum comfort during the COMFORT programme. The processor within the thermostat starts the boiler operation at the optimum time to achieve the setpoint temperature at the start of the occupancy period.

In this mode, the priority is given to anticipating and maintaining the comfort temperature during periods of occupancy.

## - Optimisation choice

The OPTI COMFORT mode is activated by default.

- 1- Move the programming slider to position .

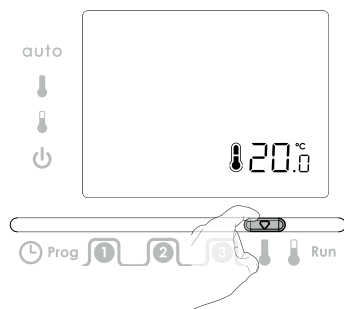

- 2- Press and hold **Enter** for 5 seconds to access the setting mode.

OP appears on the display, the set mode "CONF" and its corresponding icon flash.

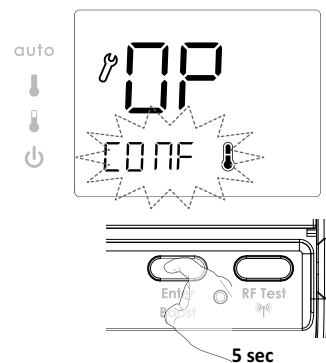

- 3- Turn the dial to select the desired mode:  
**OP CONF** = Optimisation feature activated for OPTI COMFORT mode, priority to comfort  
**OP ECO** = Optimisation feature activated for OPTI ECO mode, priority to energy efficiency  
**OP OFF** = Optimisation feature deactivated

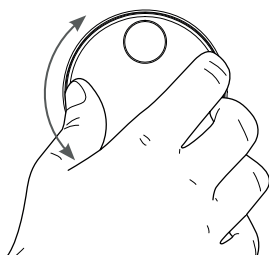

- 4- Press **Enter** to save, exit setting optimisation feature and go back to the current mode.

## ? TROUBLESHOOTING

### Display disappears on thermostat.

- Check batteries.
- Replace the 2 batteries. Only use alkaline 1.5V AA (LR6) batteries.  
**Do not use rechargeable batteries.**

### The heating does not come on or does not go off.

- Your room thermostat may have been set up close to a source of heat or on a cold wall – put it in a recommended location (see the "Installing" section on page 1 for these locations).
- Check that the communication works between the thermostat and the boiler.

### You want to change the operating mode but when you move the mode slider nothing happens.

- If the lock symbol is being displayed, then the thermostat is locked.
- Unlock the thermostat by following the instructions for doing so in the "program lock"

section (see page 2).

### The thermostat is in Auto Mode but programs are not being executed by the boiler:

- Ensure that the thermostat is in good working condition.
- Change the batteries.

### The thermostat does not control properly.

- Thermostat sensor may be influenced by a source of heat or cold.
- Check that the communication works between the thermostat and boiler.

If the problem persists, contact your installer.



## TECHNICAL SPECIFICATIONS

- Power supply: 2 alkaline 1.5 V AA (LR6) batteries.
- Battery life: approx. 2 years.
- Relay outputs: 5(2)A
- Rated impulse voltage: 4000V.
- Micro disconnection: Type 1B.
- Pollution degree: 2.
- Automatic action: 100,000 cycles.
- Class II.

Note: It is recommended to replace annually as part of the normal system service and before leaving the property empty for a prolonged period.

### Environment:

- Operation temperature: 0°C to +40°C.
- Manual temperature setting range: from +5°C to +30°C.
- Storage temperature: from -10°C to +60°C.
- Humidity: 80% at +25°C (without condensation)
- Protection rating: IP30.

**Simplified UK Declaration of conformity:** Hereby, NEOMITIS Limited declares that RT7 is in compliance with Safety Regulations 2016 (2016 No.1101), EMC Regulations 2016 (2016 No.1091) and RoHS Regulations 2012 (2012 No.3032).



The full text of the UK declaration of conformity is available at the following internet address: <https://www.neomitis.com/Home-683.html?lang=en>

**Simplified EU declaration of conformity:** Hereby, AXENCO, declares that the products mentioned in this manual are in compliance with directives 2014/35/EU, 2014/30/EU and 2011/65/EU.



The full text of the EU declaration of conformity is available at the following internet address: <https://www.neomitis.com/CE-Declaration-2126.html?lang=en>

Neomitis Ltd: 16 Great Queen Street, Covent Garden, London, WC2B 5AH UNITED KINGDOM - contactuk@neomitis.com

AXENCO: ZI Montplaisir - 258 rue du Champ de courses - 38780 Pont-Évêque - France - contact@axenco.com

### Control class and energy contribution, according to ERP 2009/125/EC and related regulations

Class IV - PID Room Thermostat, for use with on/off heating devices. Electronic room thermostat that controls both the cycle time of the thermostat and the ratio between on and off periods during the same cycle of the heating device, depending on the room temperature. PID control reduces the average water temperature, improves the accuracy of room temperature control and increases system efficiency.



The symbol , affixed on the product indicates that you must dispose of it at the end of its useful life at a special recycling point, in accordance with European Directive WEEE 2012/19/EU. If you are replacing it, you can also return it to the retailer from which you buy the replacement equipment. Thus, it is not ordinary household waste. Recycling products enables us to protect the environment and to use less natural resources.

# NEOMITIS

Creating innovative solutions for ambient comfort

NEOMITIS® LIMITED - 16 Great Queen Street, Covent Garden, London, WC2B 5AH UNITED KINGDOM  
Registered in England and Wales No: 9543404  
Tel: +44 (0) 2071 579 967 - Fax: +44 (0) 2071 250 267 - E-mail: contactuk@neomitis.com



[www.neomitis.com](http://www.neomitis.com)

# NEOMITIS

## OPERATING

# INSTRUCTIONS

RTE7D  
RTE7BD

## WIRED DIGITAL 7 DAY PROGRAMMABLE ROOM THERMOSTAT

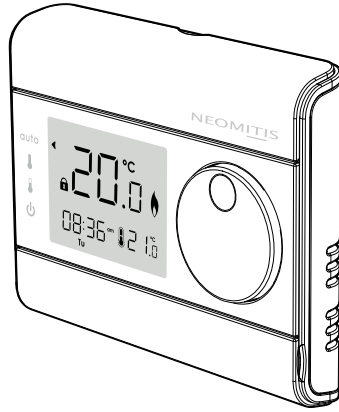

## TABLE OF CONTENTS

Overview.....	1
Controls and display .....	1
Settings .....	1
Initial power up .....	1
Programming.....	2
Set date and clock.....	2
Set the program day .....	2
Set the program Comfort period.....	3
Temperatures setting .....	3
Operating .....	4
Mode selection and description .....	4
Manual: a temporary change .....	4
Boost.....	4
Factory settings .....	4
Troubleshooting .....	4
Technical specifications .....	5
Note.....	5
What is a room thermostat.....	5

## OVERVIEW

Thank you for purchasing our RT7PLUS, 7 day programmable digital room thermostat. It is by listening to your requirements we have created and designed our products to be easy to operate and install. It is this ease of operation that is intended to make your life easier and help you save energy and money.

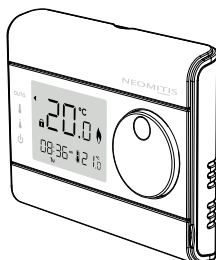

## CONTROLS AND DISPLAY

### • Thermostat

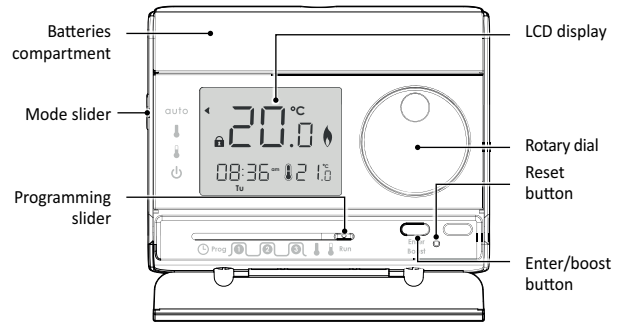

### Programming sliders sequences:

Time/date → Day to be programed → Comfort period setting → Comfort temperature → Eco temperature → Run.



### • LCD Display

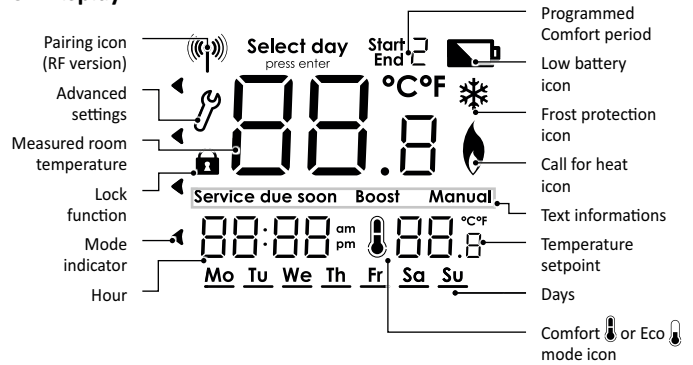

## SETTINGS

### INITIAL POWER UP

1- To start: insert the two AA batteries provided into the battery compartment. Once batteries are fitted all symbols will be displayed on the LCD screen as shown for two seconds.

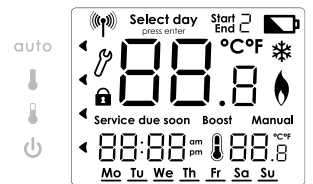

2- After 2 seconds, the LCD will show:  
- The ambient temperature (°C) solid.



**Note:** When the batteries must be changed, a low battery level indicator appears in the display. Remember to take used batteries to battery collection points so they can be recycled.



# PLEASE READ BEFORE PROGRAMMING YOUR THERMOSTAT

## OPTIMISATION EXPLAINED

### WHAT IS OPTIMISATION – OPTIMUM START?

Historically, most UK heating systems waste vast amounts of energy by firing unnecessarily early for most of the year. Homeowners tend to set their boiler on times based on when they wake up by guessing what time they feel that their boiler should fire in order to reach the requested target temperature; for example turning the boiler on at 6am in order to have a warm room/ home by their wake up time at 7am.

**Dual function optimisation, priority to comfort or energy savings, the choice is yours:** Depending on various parameters: room inertia, ambient temperature, desired temperature, the thermostat calculates and optimizes the programming for each heating period whether set to Comfort or Savings (Eco):

#### In OPTI COMFORT mode, priority to comfort

In **OPTI COMFORT mode**, the thermostat's inbuilt algorithm optimises in order to guarantee maximum comfort during the COMFORT programme.

----- Thermostat

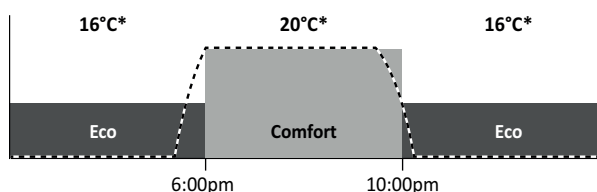

\*Default temperature setting

The processor within the thermostat starts the boiler operation at the optimum time to achieve the setpoint temperature at the start of the occupancy period.

In this mode, the priority is given to anticipating and maintaining the comfort temperature during periods of occupancy.

#### In OPTI ECO mode, priority to energy savings

In **OPTI ECO mode**, the thermostat's inbuilt algorithm optimises in order to guarantee maximum energy savings throughout the ECO programme.

----- Thermostat

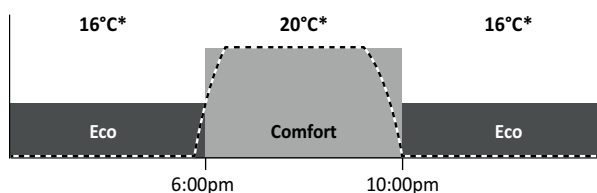

\*Default temperature setting

In this mode, a slight drop in the temperature level at the beginning and end of the comfort period is allowed to maximize energy savings.

Instead of using a fixed start time, Optimum Start calculates how long the house will take to warm up depending on the temperature of the home, then fires the boiler automatically at the most efficient moment in order to reach your target temperature by your programmed time.

### HOW DOES OPTIMUM START WORK?

Optimum Start works on a daily basis. You set the time that you want to be warm and Optimum Start will do the rest; for example - **if you wake up at 7:30AM, then set your thermostat's start time for 7:30AM.** Optimum Start ensures that you are warm when you want to be (and not before), reducing wasted energy and saving money (up to 10% of energy costs).

To change the optimisation type, refer to the installation instructions/ advanced installer settings..



# PROGRAMMING

## SET DATE AND CLOCK

- 1- Move the Programming slider to position **Prog**. The default year 2019 is flashing. Turn the dial clockwise to increment the year. Turn the dial counter-clockwise to decrement the year.



Press **Enter** to confirm and go to next setting.

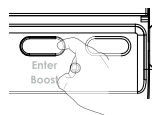

- 2- The default month 01 is flashing. Turn the dial clockwise to increment the month. Turn the dial counter-clockwise to decrement the month.

**01** = January; **02** = February; **03** = March; **04** = April; **05** = May; **06** = June; **07** = July; **08** = August; **09** = September; **10** = October; **11** = November; **12** = December.

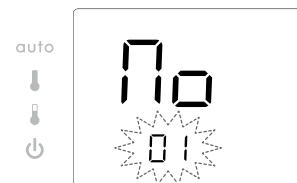

Press **Enter** to confirm and go to next setting.

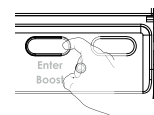

- 3- The default day 01 and the corresponding day underlining are flashing. Turn the dial clockwise to increment the day. Turn the dial counter-clockwise to decrement the day.

**Mo** = Monday ; **Tu** = Tuesday ; **We** = Wednesday ; **Th** = Thursday ; **Fr** = Friday ; **Sa** = Saturday ; **Su** = Sunday

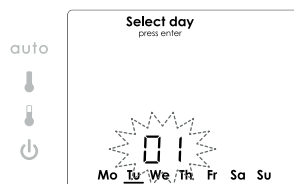

Press **Enter** to confirm and go to next setting.

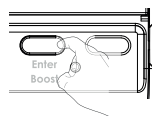

- 4- The default time 12.00 is flashing. To set the current time, turn the dial clockwise, to increment the time, turn the dial counter-clockwise, to decrement the time.

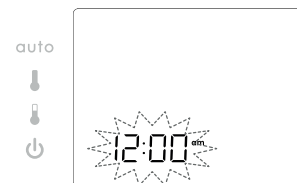

Press **Enter** or slide the programming slider to any other position to confirm/finish this setting.

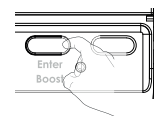

**Note regarding the clock:** The summer/winter change will be performed automatically by the room thermostat.

To disable this feature, refer to the installation instructions/ advanced installer settings.

## SET THE PROGRAM DAY

- 1- Move the Programming slider to position **Prog**. The current day setting is flashing. The default day is Monday.

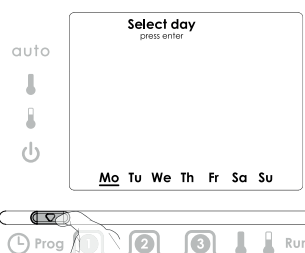

- 2- **Option 1:** Single day programming. Rotate dial to day required, eg Monday, press **Enter**. Underscore will become solid. Move the Program slider to any other position to confirm/finish this setting.

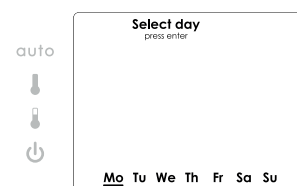

**Option 2: Multiday programming.**  
 Select first day by pressing enter then turn the dial to right, to add additional days to be programmed and press Enter to confirm each additional day.  
 Move the Program slider to any other position to confirm/finish this setting.

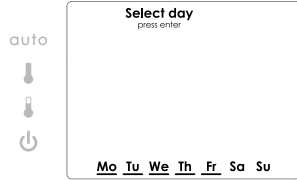

## SET THE PROGRAM COMFORT PERIOD

1- To set the first Comfort start time, move the Programming slider to position 1. The default time is 6:30am.



2- Turn the dial to set the time. Move the Program slider to the next position to confirm/finish this setting.



3- To set the first Comfort end time, move the Programming slider to position 1. The default time is 8:30am.



4- Turn the dial to set the time. Move the Program slider to the next position to confirm/finish this setting.

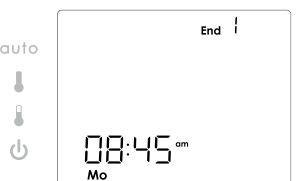

5- Repeat for the second comfort period 2, and for the third comfort period 3.

Comfort period	Default times	
Comfort period 2	Start at 12:00 pm	End at 02:00 pm
Comfort period 3	Start at 05:00 pm	End at 10:00 pm

Note: if you wish not to use a period then this can be done by Coinciding the End time with Start time.

## Customizable default Comfort temperature

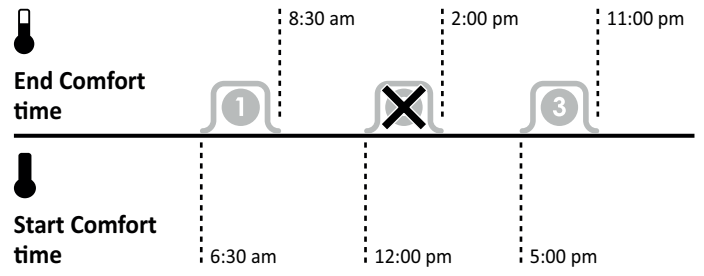

## TEMPERATURES SETTING

Two temperatures can be set: Comfort temperature and Economy temperature.

1- To set the Comfort temperature, move the Programming slider to position 1. The default temperature is 20°C (68°F).

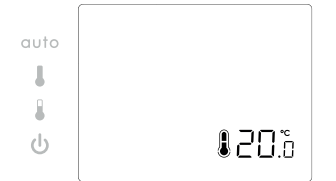

2- Turn the dial to set the temperature between 5°C and 30°C, in increments of 0.5°C. Move the Program slider to the next position to confirm/finish this setting.

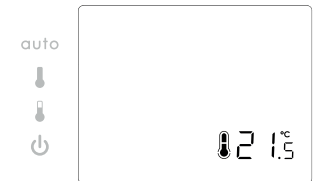

3- To set the Economy temperature, move the Programming slider to position 1. The default temperature is 16°C (61°F).



4- Turn the dial to set the temperature between 5°C and 30°C, in increments of 0.5°C. Move the Program slider to the next position to confirm/finish this setting.

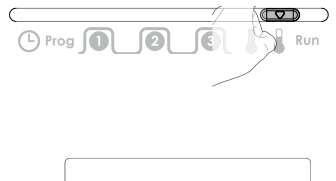

NOTE: This is the temperature that the unit will work to outside of your comfort periods.

5- Move the program mode slider to the Run position to confirm and finish all previous settings.

# ▶ OPERATING

## MODE SELECTION AND DESCRIPTION

### Mode sliders sequences:

Auto mode → Comfort mode → Economy mode → Standby.

**AUTO:** Automatic mode. The unit is controlling to the time and temperature program that have been selected (refer to "programming" section page 2).



**COMFORT:** Permanent comfort mode. The unit is controlling continuously to the comfort temperature setpoint. The default temperature setting is 20°C (68°F). Refer to section temperatures setting to change the value page 3.



**ECO:** Permanent eco mode. The unit is controlling continuously to the eco temperature setpoint. The default temperature setting is 16°C (61°F). Refer to section temperatures setting to change the value page 3.



**STANDBY:** Permanent standby mode with frost protection. The unit is controlling continuously at the frost protection temperature factory set. i.e 8°C. The ambient temperature will be displayed.

Use it when you will be away from your home for a long time to protect your installation against frost.

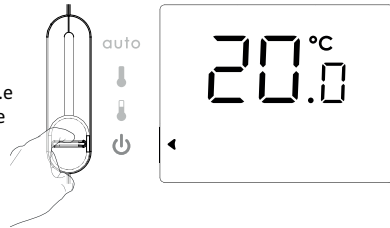

## MANUAL: A TEMPORARY CHANGE

**MANUAL:** Indicates when the temperature has been moved from setpoint. This temperature will operate until the next switching time. This is only active when the controller is in AUTO or COMFORT mode.



## BOOST

**BOOST:** Boost mode is a temporary mode which allows you to operate at the comfort temperature for 1 hour. At the end of 1 hour the device will revert to its prior setting.

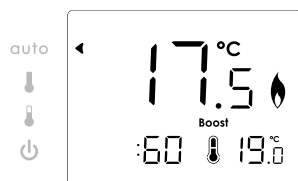

BOOST will work from any running mode. BOOST is entered by pressing Enter/Boost button.

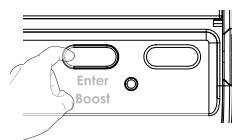

## FACTORY SETTINGS

BOOST is cancelled by any press of button, movement of dial or slider. When BOOST is running the time and day disappear. The minute array will count down from 60 – 0 to indicate time left in BOOST mode.

Note: the Programming slider must be in the Run position.

Settings	Factory settings	
Comfort temperature	20°C	
Eco temperature	16°C	
Comfort period 1	Start at 06:30 <sup>am</sup>	End at 08:30 <sup>am</sup>
Comfort period 2	Start at 12:00 <sup>pm</sup>	End at 02:00 <sup>pm</sup>
Comfort period 3	Start at 05:00 <sup>pm</sup>	End at 10:00 <sup>pm</sup>

Note: To restore factory settings, press and hold down this part for more than 3 seconds using the tip of a pen.

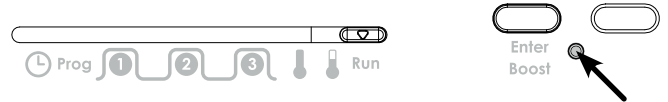

All LCD display will be turned ON for 2 seconds and the factory settings will be restored.

## ? TROUBLESHOOTING

### The boiler is not heating:

- Check that the Thermostat is calling for heat if yes then the thermostat would appear to be working check that the boiler has not switched itself off. If no increase set temperature.
- Check the position of the batteries. Remove them for 30 seconds and reinsert them. If the problem persists, replace the 2 batteries.

### Nothing in the display :

- Check the position of the batteries. Remove them for 30 seconds and reinsert them. If the problem persists, replace the 2 batteries.

### The room temperature is not high enough, the boiler is not providing enough heat:

- Check the active operating mode (see page 4) - the room thermostat may be in an Eco, Standby or Auto Mode entailing a temperature drop.
- Check the active desired temperature and increase it if needed (see page 3).

### The temperature in the room is lower than the setpoint temperature:

- Check the programming. The thermostat could be in a scheduled Eco period.
- Ensure that the time displayed is the same as the current time.

### You made a mistake while setting:

- You just need to restore factory settings, as explained in the "Factory settings" section (see page 4). This will reverse any changes you might have made.

### The system is not heating but is on:

- If the flame icon and indicator light is on but the system remains cold, then you should contact your installer.

### The thermostat is programmed and you observe a delay between the active mode Comfort or Eco and your requirement:

- The optimisation function can generate slight offsets to guarantee the level of comfort at the right time or to save energy by slightly anticipating an Eco passage.

### Heating comes on before programmed start time and comes off after programmed end time:

- Thermostat maybe set to OPTI Comfort mode. The thermostat will start the boiler at the optimum time to achieve the set point temperature at the start of the occupancy period. (On cold days your heating may come on earlier than expected in order for the programmed occupied temperature to be achieved).
- To change the optimisation type, refer to the installation instructions.

### Heating does not come on at programmed start time and comes off before programmed end time:

- Thermostat maybe set to OPTI ECO mode. The thermostat will stop the boiler at the optimum time to slightly reduce the set point temperature before the end of the occupancy period. (This helps you to save money on your heating bills).
- To change the optimisation type, refer to the installation instructions.

If the problem persists, then contact your installer.

If either Service due soon or Service due appear in the display then contact your installer or land lord.





## TECHNICAL SPECIFICATIONS

Please refer to the installation instructions for any informations about batteries life, standards and product environment.

### **i** NOTE

In some instances the unit may have been set with the service interval function enabled. By Law in rented accommodation, your gas boiler should be inspected/serviced annually to ensure it is working correctly.

This option is designed to remind the end user to contact the relevant person to have the annual service carried out on the boiler.

This function will be enabled and programmed by your Installer, maintenance Engineer, or Landlord.

If it has been set to do so, the unit will display a message on the screen to remind you that a boiler service is due.

The Service Due Soon countdown will be indicated up to 50 days before the Service is due to allow time to arrange for an engineer to attend, normal functions will continue during this stage.

At the end of this service due soon period, the unit will go to Service Due OFF at which point only the 1hour boost will operate on TMR7 and PRG7, if the unit is a thermostat RT1/RT7PLUS, it will operate at 20°C during this hour.

If PRG7 RE, Thermostat has no function.



## WHAT IS A ROOM THERMOSTAT



... an explanation for householders

A room thermostat simply switches the heating system on and off as necessary. It works by sensing the air temperature, switching on the heating when the air temperature falls below the thermostat setting, and switching it off once this set temperature has been reached.

Turning a room thermostat to a higher setting will not make the room heat up any faster. How quickly the room heats up de-

pends on the design of the heating system, for example, the size of boiler and radiators. Neither does the setting affect how quickly the room cools down.

Turning a room thermostat to a lower setting will result in the room being controlled at a lower temperature, and saves energy.

The heating system will not work if a time switch or programmer has switched it off. The way to set and use your room thermostat is to find the lowest temperature setting that you are comfortable with, and then leave it alone to do its job. The best way to do this is to set the room thermostat to a low temperature – say 18°C – and then turn it up by one degree each day until you are comfortable with the temperature. You won't have to adjust the thermostat further. Any adjustment above this setting will waste energy and cost you more money.

If your heating system is a boiler with radiators, there will usually be only one room thermostat to control the whole house. But you can have different temperatures in individual rooms by installing thermostatic radiator valves (TRVs) on individual radiators. If you don't have TRVs, you should choose a temperature that is reasonable for the whole house. If you do have TRVs, you can choose a slightly higher setting to make sure that even the coldest room is comfortable, then prevent any overheating in other rooms by adjusting the TRVs.

Room thermostats need a free flow of air to sense the temperature, so they must not be covered by curtains or blocked by furniture. Nearby electric fires, televisions, wall or table lamps may prevent the thermostat from working properly.



# NOTES

---

A series of horizontal dotted lines for writing notes, spanning the width of the page.



---

---

# NEOMITIS

Creating innovative solutions for ambient comfort

NEOMITIS® LIMITED - 16 Great Queen Street, Covent Garden, London, WC2B 5AH UNITED KINGDOM  
Registered in England and Wales No: 9543404  
Tel: +44 (0) 2071 579 967 - Fax: +44 (0) 2071 250 267 - E-mail: [contactuk@neomitis.com](mailto:contactuk@neomitis.com)



[www.neomitis.com](http://www.neomitis.com)